

Panasonic[®]

WEDEATSU
WAVE[™]

**Household
Massage Lounger
Sillón de Masaje Doméstico
Fauteuil vibromasseur**

Operating Instructions Instrucciones de Uso Mode d'emploi

Model/Modelo/Modèle No. **EP1272**



Before operating this unit, please read these instructions completely, and save for future reference.

Antes de utilizar esta unidad, lea completamente estas instrucciones y guárdelas para referencia futura.

Avant d'utiliser cet appareil, nous vous recommandons de lire l'ensemble de ces instructions et de les ranger dans un endroit accessible pour une consultation ultérieure.

INDEX

English

See pages 1-24

INDICE

Español

Ver página S1-S24

INDEX

Français

Reportez-vous à la page F1-F24

IMPORTANT SAFETY INSTRUCTIONS

Basic precautions should always be followed when using an electrical unit, including the following.

Please ensure that you read all instructions before using the Household Massage Lounger.

DANGER – To reduce the risk of electric shock:

1. Always unplug the unit immediately after use.
2. Always unplug the unit before cleaning.

WARNING – To reduce the risk of burns, fire, electric shock, or injury to persons:

1. Always insert the power plug all the way into the outlet to reduce the risk of short-circuit and fire.
2. The unit should never be left unattended when plugged in. Always unplug the unit when not in use.
3. Close and continuous supervision is necessary when the unit is used by people who are limited in their ability to move or communicate.
4. Only use the unit for the purpose described in these instructions.
5. Do not stand on the unit.
6. Do not use any accessories other than those recommended by the manufacturer.
7. This unit should not be used by children. Keep children away from the unit. Always return the seat to the upright position and retract the legrest completely to avoid possible injury. Make sure that nothing is in the way when retracting the legrest. Remove key when not in use and store out of reach of children.
8. Never operate the unit if it has a damaged power cord or plug. Return the unit to the nearest authorized service center if it is not working properly, if it has been dropped or damaged, or if it has been immersed in water.
9. Always raise the back cushion to check that the fabric of the unit itself has not been ripped before using the unit. Please also check other areas to ensure that the fabric has not been ripped. No matter how small the rip, if you find one then immediately stop using the unit, unplug the power cord and have the unit repaired at an authorized service center.
10. Keep power cords away from heated surfaces. Do not carry the unit by the power cord. Do not allow pins, rubbish or moisture to come into contact with the plug.
11. Do not use the unit on top of heating appliances, such as electric carpets, etc. Do not operate the unit under blanket or pillow. Excessive heating can occur and cause fire, electric shock, or injury to persons.
12. Never block the air openings during operation and make sure that all air openings are kept free of lint and hair, etc. Do not drop or insert anything into any of the openings of the unit.
13. Do not use the unit in bathrooms or other damp or humid places as this may cause electric shock or cause the unit to malfunction. Do not spill water, etc. onto the controller.
14. Do not use the unit outdoors.
15. Do not use the unit in places where aerosol spray products are in use or where oxygen is being used.
16. When unplugging the unit, turn off all controls before removing the plug from power outlet. Do not use the unit with a transformer as this may lead to malfunction or electric shock.
17. Connect this unit to a properly grounded outlet only. See Grounding Instructions.
18. To avoid electric shock or injury, do not attempt to open or disassemble any part of the unit as it contains no user-serviceable parts.

SAVE THESE INSTRUCTIONS

SAFETY PRECAUTIONS

WARNING: To avoid the risk of injury:

1. Pregnant women, people who are ill, in poor physical shape or undergoing medical treatment, and people suffering from back, neck, shoulder or hip pain should consult their doctor before using the unit. If you have a pacemaker, defibrillator, or other personal medical device, consult with the manufacturer of your device before using the unit. Your physician may be able to assist you in obtaining this information.
2. Sit down slowly after checking the position of the massage heads. Never put any part of your body between the massage heads as the squeezing action of the massage heads may cause injury. Never put your fingers or feet in the gap between the backrest and seat, the backrest and the armrest, the seat and cover under the armrest, or the gap between the legrest and the footrest. Do not place your fingers or any part of your body in the mechanism below the legrest, or between the legrest and footrest.
3. Do not allow the massage heads to be used on the head, abdomen or bare skin. Do not allow knees to come in contact with or become caught in the legrest. Protect the neck area by covering it with a towel, etc. When raising the backrest, do not allow hands or feet to become caught between the backrest and the backrest latch or the backrest and the armrests.
4. Do not allow the unit to be used on bare skin. Do not use excessively strong massage action on the back of the neck.
5. When using the massager, use the Neck Roller Position button to adjust the massage heads to the correct position. You can adjust the shoulder position in this way in the pre-programs and Rolling in the manual operation. Failure to align the shoulder position correctly can lead to injury.
6. Do not stretch the back muscles for more than approximately 15 minutes at a time. To avoid overstretching the muscles which may result in discomfort, do not use the unit for more than 5 minutes when first using it. You can gradually increase the duration and strength of the massage as you become used to it. Do not massage any one point for more than 5 minutes at a time. Excessive massaging can overstimulate the muscles and nerves and result in an adverse effect. To prevent excessive massaging, do not use the massager for more than a total of 15 minutes each session. After approximately 15 minutes, the massage heads will be retracted and stop moving. The back cushion can be removed if you want to experience a stronger back massage. Exercise extreme care when you use this mode in order to avoid back pain or injury. Use only for short periods of time (no more than 15 minutes). Reinstall the back cushion if you want to restore to normal massage intensity.
7. While using the massager, if you start feeling sick or if the massage seems painful, stop using it immediately. While using the massager, if the pressure seems too strong, the movement of the massage heads can be stopped at any time by pressing the Quick Stop button.
8. Do not go to sleep while using the unit. Do not use the unit after drinking alcohol.
9. When the seat back is in a reclined position, do not sit on it or sit with your legs resting on the headrest. Do not sit on the legrest as the unit may fall over.
10. Do not allow children or pets to play on or around the unit, especially during operation.
11. Do not unplug the unit or turn it off during operation. Unplug the unit immediately if there is a power outage.
12. If using the massager for the first time, it is recommended to start on the swedish massage program. The shiatsu massage is stronger and should be enjoyed after one has gotten accustomed to the chair.
13. Do not allow children to play on this mechanized furniture or operate the mechanism. Legrest folds down on closing so that a child could possibly be injured. Always leave in an upright and closed position. Keep hands and feet clear of mechanism. Only the occupant should operate it.

OPERATING PRECAUTIONS

WARNING: To avoid damaging the chair, follow these precautions:

1. The chair is designed for a maximum user weight of 264 lbs (120 kg). Exceeding the maximum weight may cause permanent damage to the massage mechanism and/or other components of the unit. Any such damage is deemed to be user abuse and is not covered under the Limited Warranty.
2. Do not sit on or drop the controller. Do not pull the controller cord or the power cord. Be careful not to catch the cord of the controller between the armrest and the chair back.
3. Do not treat the chair roughly, such as turning the chair on its side, turning the chair over or standing on it.
4. Do not treat the covering roughly.
 - Keep sharp or pointed objects away from the covering of the chair. Be careful not to drop lit ashes, lit cigarettes or matches on the chair.
 - Exposure to direct sunlight can cause fading or a change in color of the covering.
5. If the massager functions abnormally, immediately turn off the power and have the massager checked by an authorized service center.
6. Do not attempt to repair the massager yourself.
7. Do not repeatedly operate any switch at short intervals. Such action may cause the switch to malfunction.
8. Some noise may be heard coming from the massager while in use. This is due to the structure of the massager and is normal.
9. Make sure there are no obstacles behind the chair before reclining it. The chair can be reclined to a maximum angle of 170°. If the back hits a wall or pillar, the chair may malfunction. Be sure to have ample space behind the chair. Recline the chair slowly in order to avoid contact with an obstacle.
10. When excessive pressure is applied to the massage heads, they may stop moving for safety. When moving the heads up from the lowered position, one's body weight may stop the heads' movement. In such case, slightly raise your body and allow the massage heads to move up.
11. After each massage, slide the power switch, which is located on the right side of the chair, to the "off" position and turn its lock switch to the "lock" position.
12. Do not sit on the chair with wet body or hair.
13. The unit must not be used in "wet rooms" (sauna, swimming pool) or outdoors.

GROUNDING INSTRUCTIONS

The product must be grounded. If it should malfunction or break down, grounding provides a path of least resistance for electric current to reduce the risk of electric shock. This product is equipped with a cord having an equipment-grounding conductor and a grounding plug. The plug must be plugged into an appropriate outlet that is properly installed and grounded in accordance with all local codes and ordinances.

DANGER

Improper connection of the equipment-grounding conductor can result in a risk of electric shock. Check with a qualified electrician or serviceman if you are in doubt as to whether the product is properly grounded. Do not modify the plug provided with the product — if it will not fit the outlet, have a proper outlet installed by a qualified electrician.

This product is for use on a nominal 120-volt circuit and has a grounding plug that looks like the plug illustrated in Figure A. Make sure that the product is connected to an outlet having the same configuration as the plug. No adaptor should be used with this product.

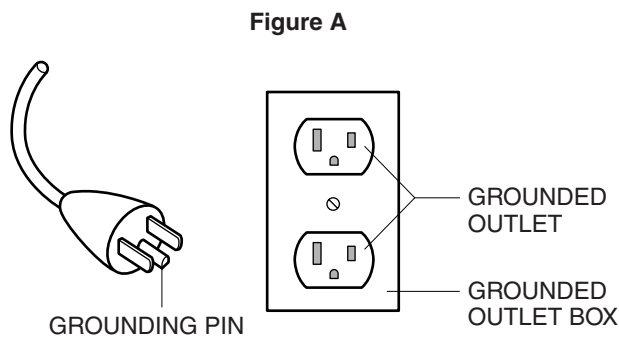

PART NAMES AND FUNCTIONS

MASSAGE LOUNGER

Front

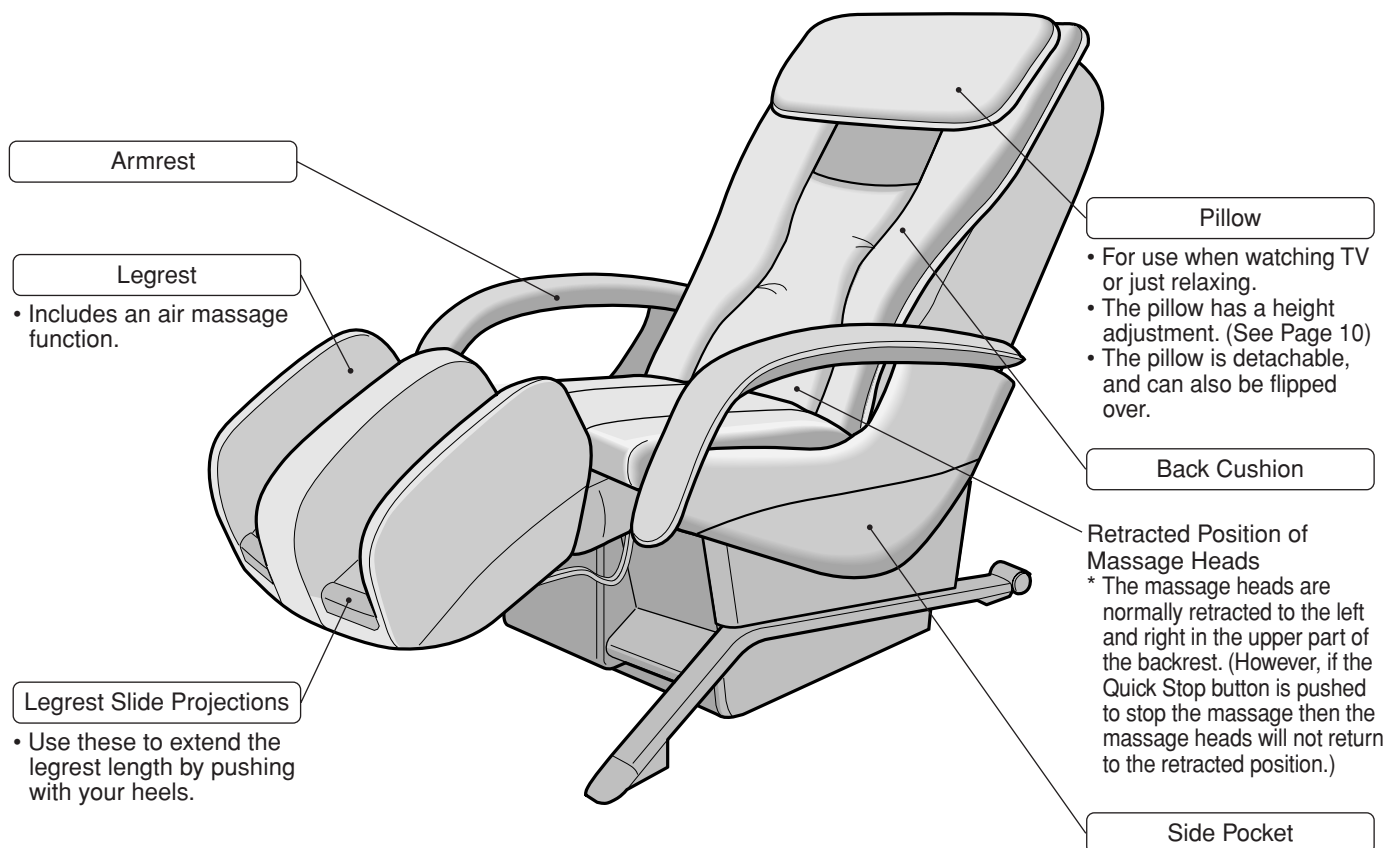

Back



CONTROLLER

Cover Closed

Cover Opened

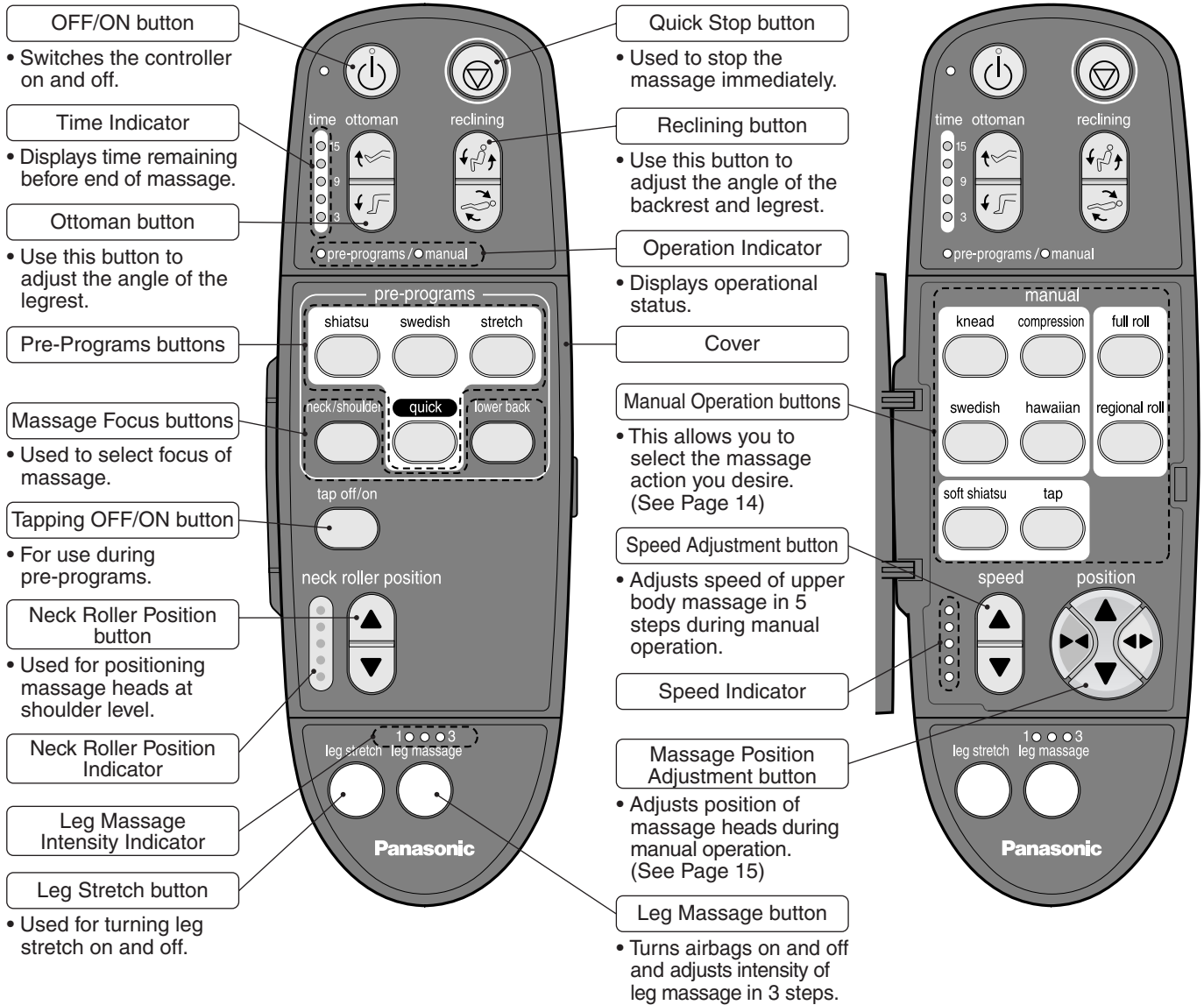

SETTING UP THE UNIT

UNPACK THE UNIT AND RAISE THE BACKREST

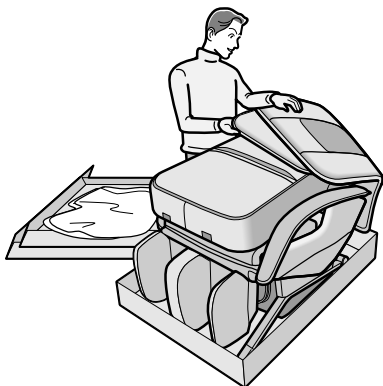

CAUTION

- When raising the backrest, do not allow hands or feet to become caught between the backrest and the backrest latch or the backrest and the armrests. Failure to follow this precaution may result in pinching, which may lead to injury.

1. Remove the top of the shipping container.

- When packed for shipping the backrest is folded forward.

2. Remove the packing and cushioning materials and take out the accessories.

3. Raise the backrest.

- Do not connect the power cord to an electrical outlet during setup.
- Hold the backrest with both hands and lift in the direction of the arrow until it comes to a stop.



INSPECT CONTENTS OF SHIPPING CONTAINER

Massage Lounger

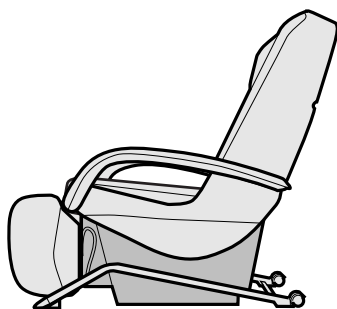

Accessories

Back Cushion

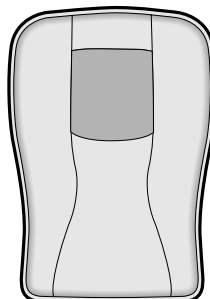

Pillow

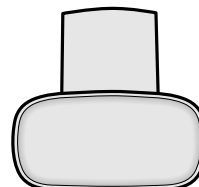

WHERE TO USE THE UNIT

Select a place where the unit can be reclined.

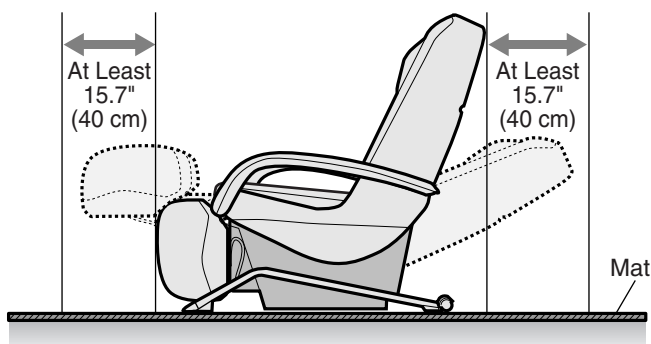

CAUTION

- Do not use the unit in areas with high humidity, such as the bathroom, etc. as this can lead to electric shock or other accidents.
- Place the unit on a totally flat surface. Failure to do so may result in the seat tipping over.
- Avoid places where the unit will be exposed to direct sunlight for long periods of time or places where it will be exposed to high temperatures, such as in front of a heater, etc., as this can cause discoloration or hardening of the synthetic leather.
- Placing a mat or cloth under the unit is recommended to prevent floor damage.

HOW TO MOVE THE UNIT

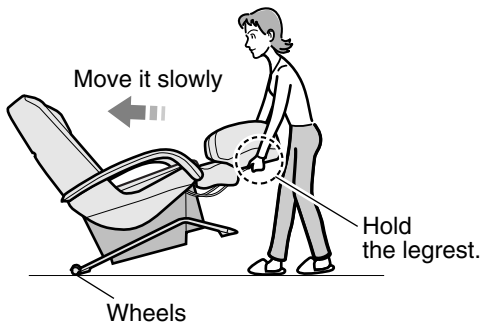

CAUTION

- Do not move the unit while someone is seated on it. Failure to do so may cause the unit to tip over, which may lead to damage or injury.

Using the wheels to move the unit

- Grasp the legrest to move the unit when using the wheels.
- It is easier to move the unit with the massage heads retracted and the backrest in the upright position.
- * Place a mat or cloth on the floor and move the unit slowly to prevent floor damage.

Lifting the Unit

- Move the chair by having one person hold the legrest and another person use the handles on the back.
- * Please hold the handles and legrest securely to avoid dropping the unit as it may damage your floor.

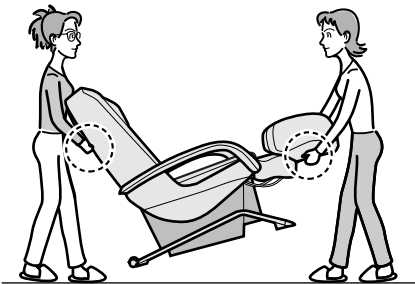

POWERING UP THE UNIT

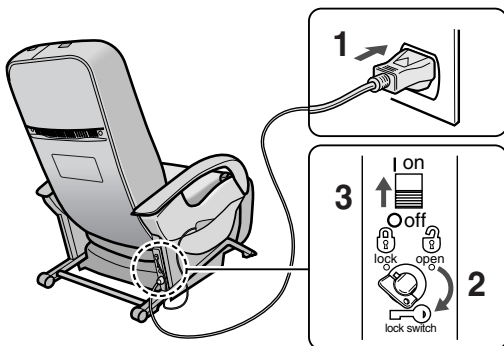

1. Plug the power plug into an electrical outlet.
2. Verify that the lock switch key is turned to the "open" position.
 - If in "lock" position, turn the lock switch key to "open".
3. Slide the power switch to the "on" position.

ATTACHING THE BACK CUSHION, PILLOW AND REAR LEG COVER

1. Attach the back cushion using the zipper.

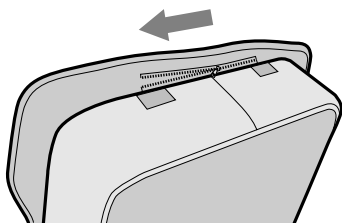

2. Attach the pillow using the fasteners.

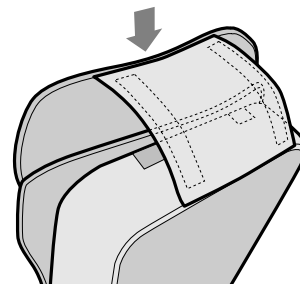

BEFORE USING THE UNIT

CHECK THE SURROUNDING AREA

Check that there is nothing around the unit.



CHECK THE UNIT

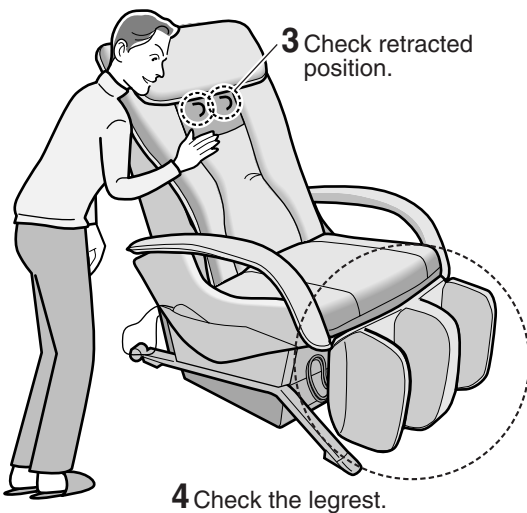
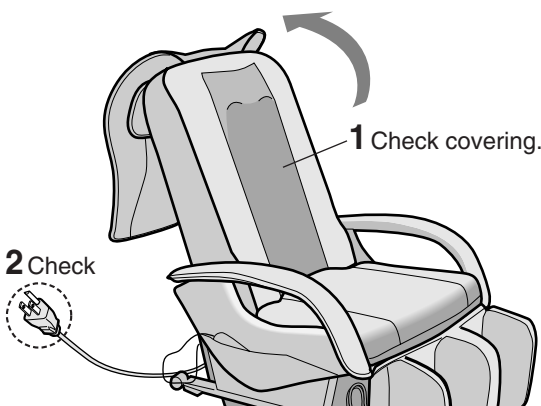

1. Make sure the covering is free of rips or tears.

2. Make sure the power plug is functional.

- Make sure the power plug is undamaged.
- Make sure the power plug is free of foreign matter and debris.

3. Make sure the massage heads are in the retracted position, i.e. they are parked to the left and right in the upper part of the backrest.

If not retracted, press  twice to return the massage heads to the retracted position.

4. Make sure the legrest is lowered.

- Do not sit on the legrest when it is raised. Doing so may cause it to collapse down or bend the legrest. The legrest is not meant to support full body weight.

Lowering the Legrest

Pull the legrest slide lever, make sure the legrest is fully retracted, then press  twice to return the legrest to its lowest position.

ADJUSTING THE SEAT

ADJUSTING THE RECLINING ANGLE

Press  and  to adjust the angle of the backrest and legrest.

- With either button held down, movement will continue until a “beep-beep-beep” sound indicates the legrest or backrest has been raised or lowered as far as possible.
- The legrest will start to move shortly after the backrest.

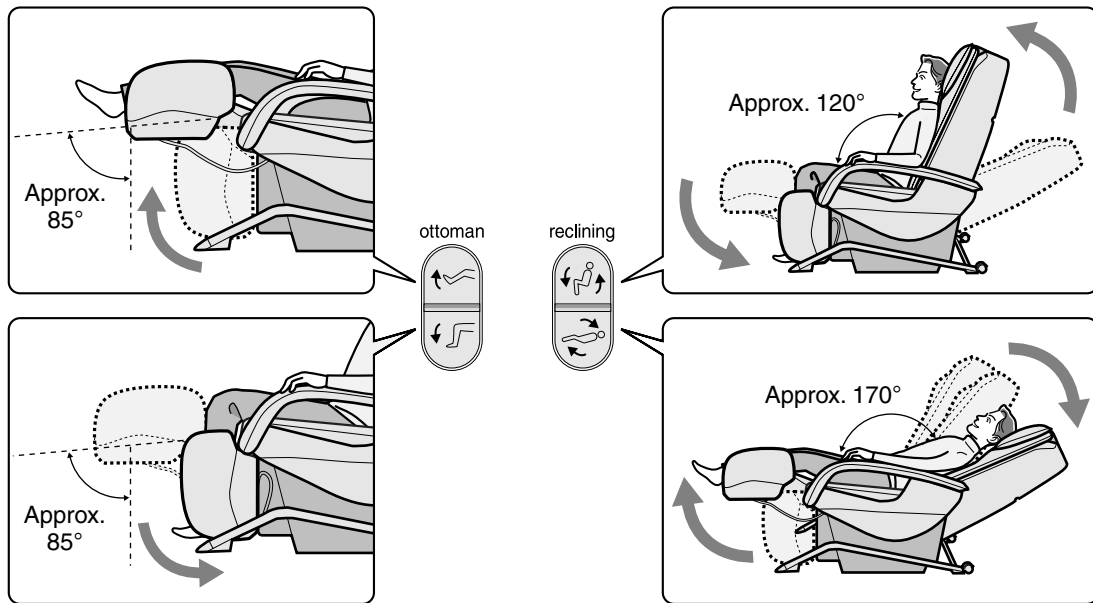

EXTENDING THE LEGREST LENGTH

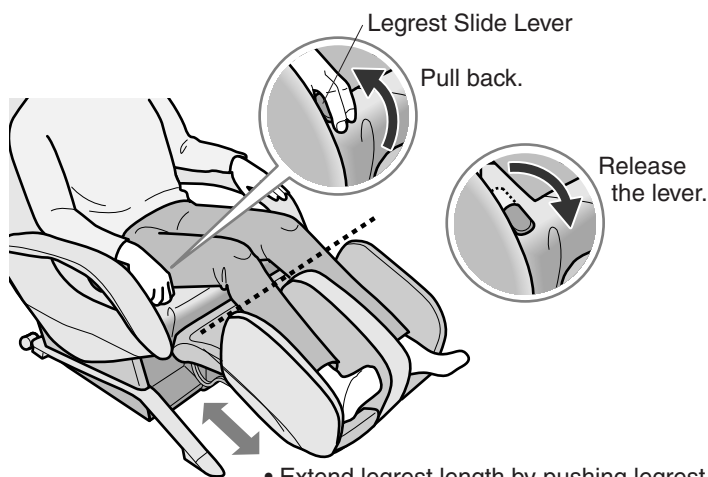

1. Pull on the legrest slide lever and extend the legrest to desired length. (maximum approx. 6 in. (15 cm)).
2. Release the legrest slide lever.

- Extend legrest length by pushing legrest slide projection with heel.
- Raise legs slightly and legrest returns.
- Extend until the end of the legrest is lower than the knees.

ADJUSTING FOR CORRECT PILLOW HEIGHT

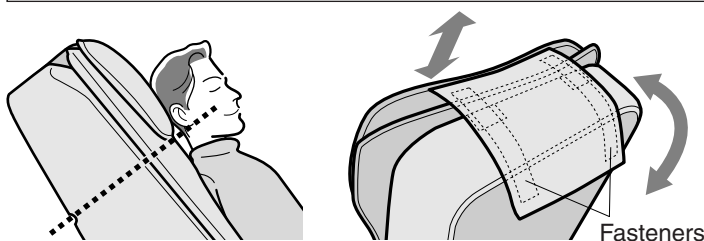

Adjust the pillow height so that the bottom edge of the pillow is at ear level.

- If positioned too low, the pillow can lessen the effect of massage around the neck area.

USING PRE-PROGRAMS AND QUICK MASSAGE

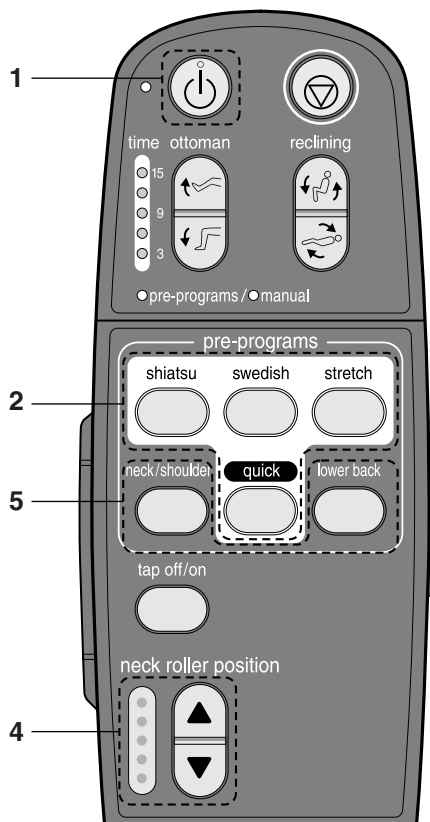

1. Press the OFF/ON button.



- The OFF/ON indicator will come on.
- You can now select one of the pre-programs or one of the manual settings.

2. Select the pre-program you want.

- Please press one of the flashing buttons.
- For a general explanation of pre-program characteristics, please refer to the bottom of this page.
- For an outline of each pre-program, please refer to the information on page 18.
- If you press another Pre-Program button during your selected pre-program massage, the massage will switch to the newly selected pre-program.

The Selected Program will Start

- It is possible to change the pre-program selected or to change to manual operation mid-way through a massage.
- In pre-programs, the leg massage begins at the same time. It is possible to stop or change the intensity of the leg massage during the program. (See Page 17)

3. Sit as far back in the seat as possible with your head on the pillow.



- Pressing a Pre-Program button automatically moves the backrest and legrest into massage position.
- If the massage lounger is reclined further than this angle then it will not automatically recline.

About the Time Indicator

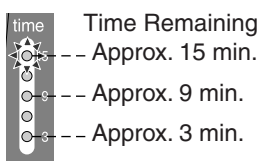

- Displays remaining massage time via flashing LED.
- Starts counting down from 15 minutes in increments of approximately 3 minutes.
- Flashing speeds up one minute before end of massage.

Pre-Program and Quick Massage Characteristics

Shiatsu: Uses mainly Soft Shiatsu, Tap and Knead actions to comfortably loosen and provide relief from tension held at pressure points. Recommended for those with severe stiffness or who prefer a stimulating massage.

Swedish: Uses mainly Swedish, Hawaiian and Knead actions to evenly apply muscle-relaxing strokes all over. Recommended for those who are just starting out or prefer a gentle massage.

Stretch: Uses mainly Full Roll, Soft Shiatsu, Compression, Knead and Leg Stretch actions to stretch out and loosen up back and leg muscles. Recommended for those who are physically inactive or troubled by tired legs.

Quick: Covers all areas using a variety of massage actions, all in a span of just five minutes. Recommended for those who want to relax quickly.

4. Adjusting shoulder position

- When a pre-program begins, the backrest and legrest automatically move the massage position where the massage heads carry out a Soft Shiatsu massage in the area around the shoulders. During the time that the shoulder position indicator is flashing (approx. 7 seconds), use the Neck Roller Position button to align the position of the massage heads to your shoulder height. Approximate positions for adjusting the position of the heads are shown below.

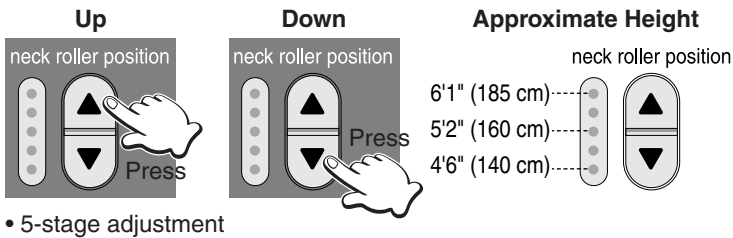

- 5-stage adjustment

Helpful Tips

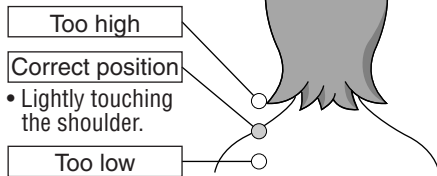

- When the shoulder position indicator is flashing, adjust the position of the massage heads (upper heads) so that they lightly touch the shoulders.
- The shoulder position can be adjusted up and down 4 in. (10 cm).
- When it is not possible to correctly adjust the shoulder position, you may have to slide your body and adjust it again.

- Persons whose height is less than 4.6 ft. (140 cm) or more than 6.1 ft. (185 cm) are recommended to use the chair in the manner described below when the massage heads do not touch their shoulders.

When height is around 4.6 ft. (140 cm) or less



Use by placing a cushion on the seat and sitting as far back as possible.

When height is around 6.1 ft. (185 cm) or more



Use by reclining the backrest and sliding your body downward.

5. Selecting an area for a focused massage

- Please see pages 14–17 for details regarding manual operation.

Massaging the Neck and Shoulders

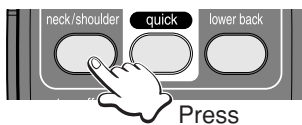

- Press this button to focus the massage on the neck and shoulders. (The upper and lower back will also be massaged slightly.)
- Press the button again to toggle it off.

Massaging the Lower Back

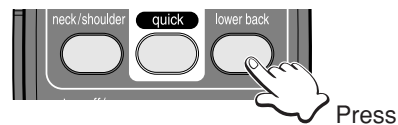

- Press this button to focus the program on the lower back. (The neck and shoulders will also be massaged slightly.)
- Press the button again to toggle it off.

6. Removing tapping from pre-programs

Removing Tapping Action

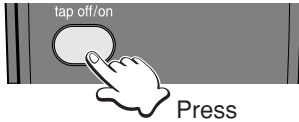

- Press this button to remove tapping in pre-programs. (The tapping will change to a kneading massage.)
- * Press the button again to restore tapping to the program.

7. Auto shut-off in pre-programs

- The massage will end after approximately 15 minutes and the unit will automatically shut off.
- The massage heads will move to the retracted position and stop.
- The OFF/ON indicator will flash until the heads have stopped moving.
- If you want to continue using the massage lounger, press the OFF/ON button. Please rest at least 10 minutes between massages.

Stopping a pre-program



- Press the OFF/ON button.
- The OFF/ON indicator will continue to flash until the massage heads have returned to the retracted position and the unit shuts off.

Immediately stopping the massage



- Press the Quick Stop button.
- All movement will stop immediately.
- The massage heads will not return to the retracted position, which may make sitting in the seat somewhat uncomfortable.
- Please press the OFF/ON button twice to return the massage heads to the retracted position.

USING MANUAL SETTINGS

MANUAL OPERATION FOR THE UPPER BODY

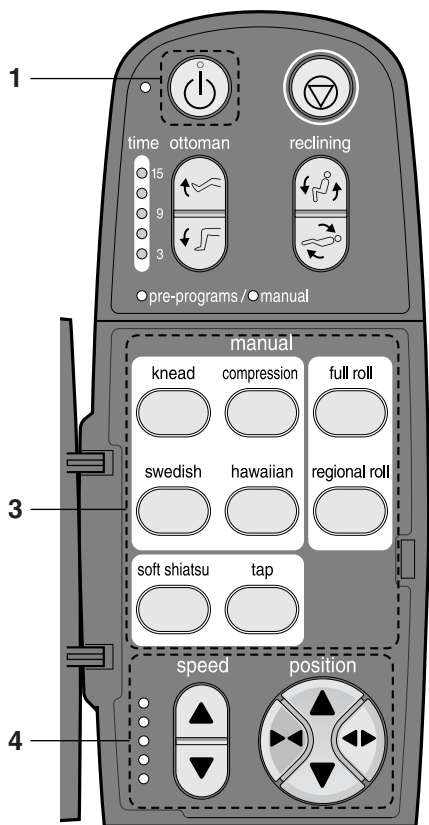

1. Press the OFF/ON button.



- The OFF/ON indicator will come on.
- You can now select one of the pre-programs or one of the manual settings.

2. Open the cover of the controller.

- All of the Manual Operation buttons will start to flash.

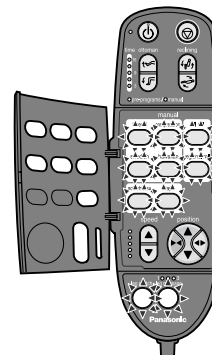

3. Select the message type you want.

- Press the button of the massage you require. The button will light up and the massage will begin.
- The unit will automatically recline to the massage position.

E.g. Selecting Knead

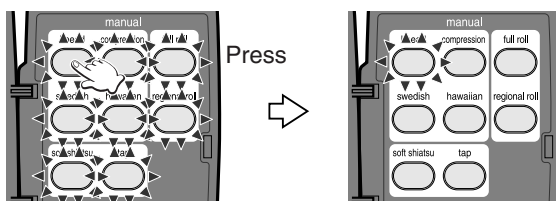

Combining Messages

- It is possible to combine message types.
- It is not possible to combine message types in the same category.

E.g. 1 Adding Tap when Knead is selected.

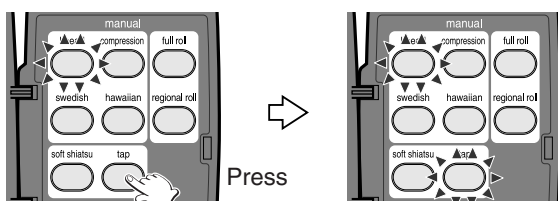

E.g. 2 Adding Full Roll to the selection.

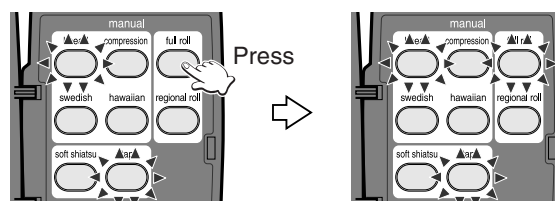

E.g. 3 Deselecting Full Roll.

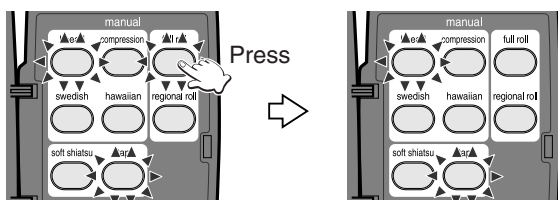

Changing Message Types

E.g. 1 Changing message types in the same category. (Changing to Hawaiian when Knead is selected.)

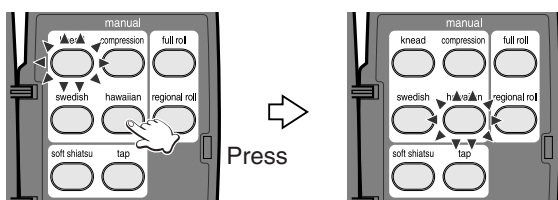

E.g. 2 Changing to a message type outside the category.

(Changing to Tap when Knead is selected.)

- When Knead is combined with Tap, deselecting Knead will leave only Tap.

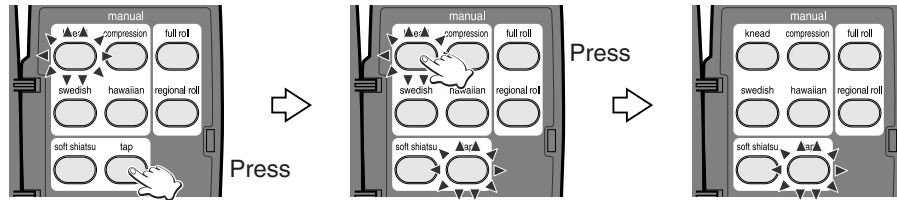

4. Adjusting manual massage settings

Adjusting the Vertical Position of the Massage Heads

Message heads up

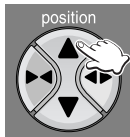

Message heads down

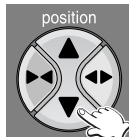

- The massage heads will move a little each time the button is pressed. If you hold down the button, the massage heads will continue to move until you release the button. When the massage heads reach their limit you will hear a “beep-beep-beep” sound.

Adjusting the Width between Massage Heads

Increasing the width

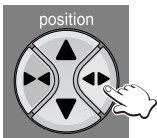

Decreasing the width

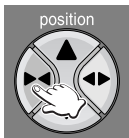

- Tap, Soft Shiatsu, Full Roll, and Regional Roll can be adjusted in 3 steps.
- The massage heads will move a little each time the button is pressed. If you hold down the button, the massage heads will continue to move until you release the button.
- When the massage heads reach their limit you will hear a “beep-beep-beep” sound.

Adjusting Massage Speed

Increasing message speed

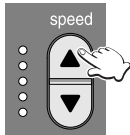

Decreasing message speed

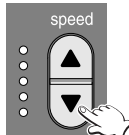

- Massage speed is adjustable in 5 steps.
- When the massage speed reaches its maximum or minimum limit you will hear a “beep-beep-beep” sound.

5. Auto shut-off in manual operation

- The massage will end after approximately 15 minutes and the unit will automatically shut off.
- The massage heads will move to the retracted position and stop.
- The OFF/ON indicator will flash until the heads have stopped moving.
- If you want to continue using the massage lounger, please press the OFF/ON button. Please rest at least 10 minutes between massages.

NOTE:

- A built-in timer prevents overuse of the unit.
- When using manual operation, the timer automatically stops operation after 15 minutes.
- * If you want to continue to use the unit, we recommend that you have a break of at least 10 minutes between massages to allow your body to rest.

Stopping mid-way through a massage



- Press the OFF/ON button.
- The massage heads will return to the retracted position and stop.

MASSAGE ACTIONS

Knead



Feels like the fingers and thumbs of two hands squeezing in unison as they carefully work their way upwards to loosen stiffness.
Recommended for the area of the neck and shoulders.

Compression

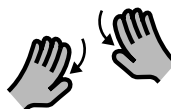

Applies fluent alternating strokes to the left and right sides as if drawing stiffness to the outside.
Recommended for relaxation of the whole body.

Swedish



Feels like a two palms gliding over the skin as they rhythmically knead the muscles beneath.
Recommended for loosening up large areas of the back.

Hawaiian



Feels like two hands moving rhythmically in a circular pattern to relax and refresh the back.
Recommended for relieving tension in the lower back.

Soft Shiatsu



Feels like a pair of thumbs carefully alternating between the right and left sides as they zero in on their target.
Recommended for loosening up knots of tension.

Tap



Feels like the edges of two hands rhythmically tapping to penetrate into the body and relax muscles. Recommended for use on the fine muscles of the neck or as a finishing massage.

Full Roll



From lower back to neck, you can feel it move 27 in. (67.5 cm) up and down the whole of the upper body.
Recommended for overall stretching of the back muscles.

Regional Roll



You can feel it travel up and down working on 4 in. (10 cm) localized areas of the back.
Recommended for focused rolling out of back muscles.

MANUAL OPERATION FOR THE LOWER BODY

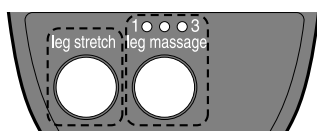

Adjust the angle and length of the legrest before starting a massage.
(See Page 10)

Using the leg air massage

1. Press the OFF/ON button.



- The Pre-Programs and Leg Massage buttons will begin to flash.

2. Press the Leg Massage button.

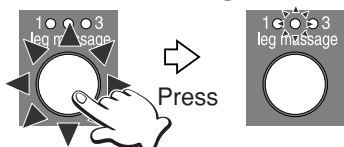

- The air massage will begin.
- Leg massage intensity is displayed by the indicator.
- The reclining angle can be adjusted during the massage. The airbags will deflate while the Reclining button is held down so that you can reposition your legs.

3. Adjusting the massage intensity

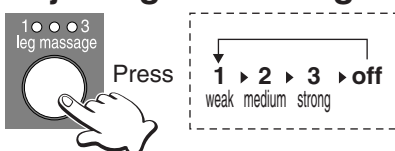

- The intensity is adjustable in 3 steps.
- The intensity will move 1 step each time the button is pushed, moving in order of medium, strong, off and weak.
- Default is level 2.

4. Auto shut-off in leg massage/stretch

- The massage will end after approximately 15 minutes and the unit will automatically shut off.
- If you want to continue using the massage lounger press the OFF/ON button.

Using the leg stretch

1. Press the OFF/ON button.



- The Pre-Program and Leg Massage buttons will begin to flash.

2. Press the Leg Stretch button.



- Press again to stop the leg stretch.

3. Auto shut-off in leg massage/stretch

- The massage will end after approximately 15 minutes and the unit will automatically shut off.
- If you want to continue using the massage lounger press the OFF/ON button.

Description of Leg Massage/Stretch

Leg massage

A hand-like grasping action loosens calf muscles in three stages while a bottom-to-top squeezing action slowly relaxes and softens to comfortably alleviate tired, swollen legs.

Leg stretch

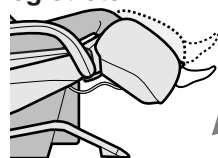

Lowered to approx. 15°

After the legs have been grasped by the airbags, they are slowly stretched as the legrest lowers to a 15° angle.

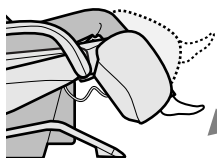

Lowered to approx. 20°

The legrest then rises to an 70° angle, after which it lowers once again to a 20° angle for a deep stretch.

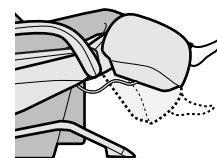

Raised to approx. 70°

The legrest rises again and returns to its original angle.

Stopping mid-way through a massage



- Press the OFF/ON button.
- It will take some time before the air is completely evacuated.
(The sound of air escaping may be audible after pressing the OFF/ON button.)

Additional Information

Overview of Pre-Program and Quick Massages

Shiatsu

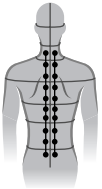

Overall stimulation with soft shiatsu from neck to lower back.



Carefully stimulates area of neck and shoulders with soft shiatsu.



Focuses on area of lower back using a deep rubbing-type action.



Carefully stimulates with tapping at points from neck to lower back.



Carefully stimulates using soft shiatsu on area at base of neck.



Relaxes by carefully kneading and tapping from neck to lower back.

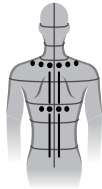

Percussively strokes at points on shoulders, shoulder blades and spine.



Finishes with overall massage to loosen and relax.

Swedish



Overall loosening with wide rubbing strokes from neck to lower back.



Thoroughly massages to gradually loosen area of neck and shoulders.

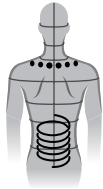

Focuses on area of lower back with rubbing action in circular pattern.



Loosens in stages with massage from neck to lower back.



Thoroughly massages with rhythmic action on neck and shoulders.



Rhythmically massages with squeezing action on upper and lower back.



Thoroughly massages to gradually loosen area of neck and shoulders.



Finishes with broad strokes for overall massage.

Stretch



Stretches back muscles by gradually moving from neck to lower back.



Gradual pressing action that works on area at base of neck.

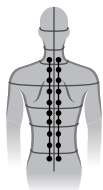

Uses shiatsu on back muscles working from neck to lower back.



Pressing-type action alternates as it moves from neck to lower back.



Kneads area of back working upwards from lower back to neck.



Uses shiatsu on back muscles working up from lower back to neck.

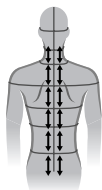

Applies meticulous kneading action up and down back muscles.



Uses alternating compression and shiatsu moving from neck to lower back.

Quick



Gradually loosens area of neck and shoulders.



Rhythmical loosening action works along length of body.



Rhythmical action thoroughly loosens area of neck and shoulders.

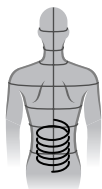

Focuses on area of lower back with rubbing action in circular pattern.



Focuses on lower back with squeezing-type massage action.

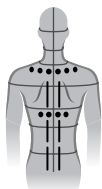

Loosens shoulders, shoulder blades and spine with tapping action.



Loosening over wide area along length of body with rhythmic tapping.



Carefully loosens area at base of neck.

AFTER COMPLETING THE MASSAGE

RETURN THE SEAT TO THE ORIGINAL POSITION



1. Check that there is nothing in the vicinity of the backrest or the legrest.

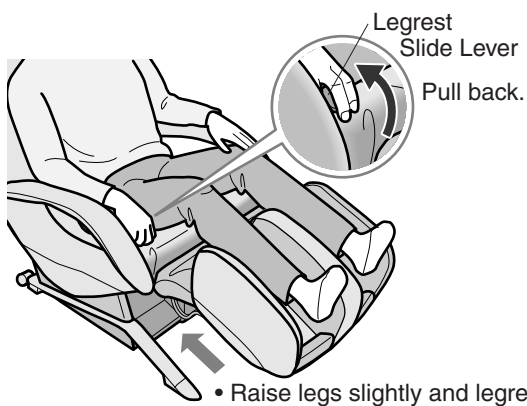

2. Always retract the legrest after use if you have extended it.

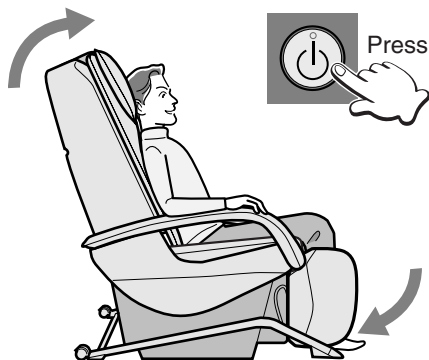

3. Press the OFF/ON button twice.

- The backrest and legrest will automatically return to their original positions.

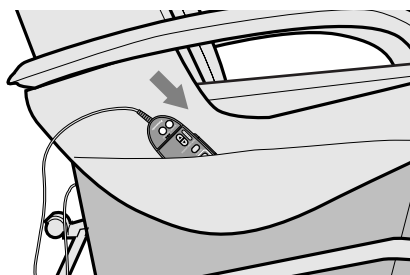

4. Place the controller in its holder.

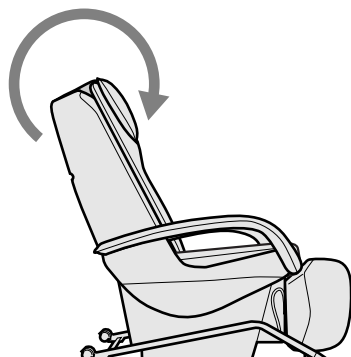

5. Return the pillow and the back cushion to their original positions.

DISCONNECT THE POWER

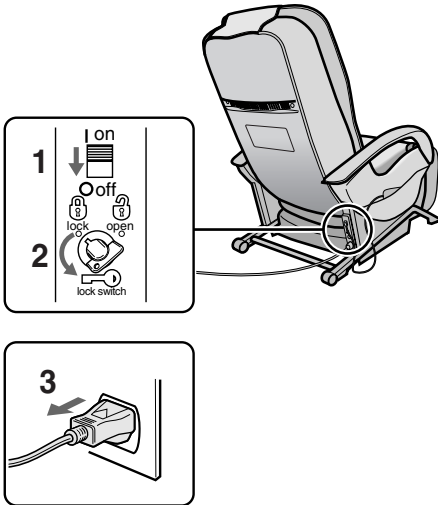

1. Slide the power switch to the “off” position.
2. Turn the lock switch key to the “lock” position.
* Remove key and store out of reach of children.
3. Unplug the power cord.

FOLDING THE BACKREST FORWARD (REPACKING)

CAUTION

- **Keep hands, feet, children, objects, etc., clear of openings on the unit, including seat, armrests and legrest; gaps between the unit and the floor; and the backrest’s range of movement when being folded forward.**
Failure to do so could result in injury due to pinching.
- **Do not turn on power or operate controls with backrest folded forward.**
Doing so could result in injury due to pinching.
- **Do not climb on or place objects on top of back cover with backrest folded forward.**
Doing so could result in damage to the unit.
- **In the interests of safety, the backrest should always be folded forward by two persons.**

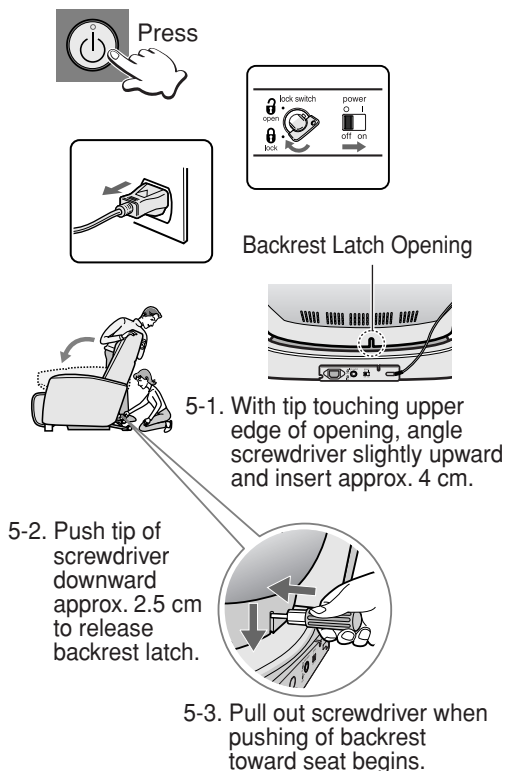

1. Press the OFF/ON button to switch off the power. (The massage heads should return to their retracted position in upper part of the backrest.)
2. Slide the power switch to the “off” position, lock it, and then unplug the power cord.
3. Remove the back cushion and pillow from the chair.
4. Remove the rear leg cover.
5. Insert a screwdriver or similarly shaped blunt tool into the opening at the bottom of the back cover. The tool should be angled slightly up rest on the top of the latch. Push down on the latch so that it detaches. A second person should hold the backrest with both hands and slowly push it forward, folding it down onto the seat.
6. Moving the chair with the backrest in the up position is advisable. If moving with the backrest folded down, two people should move the chair by grasping the undersides of the armrests. Care should be given to not letting the chair tip or the backrest rise, especially on inclines.

CLEANING AND MAINTENANCE

LEATHER COVERING ON THE PILLOW, THE BACK CUSHION AND THE UNIT

- Wipe these areas with a soft, dry cloth.
(Do NOT use cloths containing any kind of chemical, etc.)
- If the leather is particularly dirty, dampen with liquid soap and brush the surface. Wipe with a cloth dampened with water. Allow to dry naturally.
(Do NOT use a hair dryer to try to dry the surfaces more quickly.)
- Do not allow these areas to come in contact with plastic for extended periods of time as this may lead to discoloration.
- Please do NOT use thinners, benzine or alcohol.

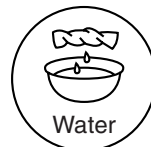

PIPE AND PLASTIC AREAS

- 1 Wipe the unit with a cloth that has been soaked in a mild detergent and then thoroughly wrung out.
 - 2 Next wipe the unit with a cloth that has been moistened with just water and thoroughly wrung out.
* Make sure you thoroughly wring out the cloth first when cleaning the controller.
 - 3 Allow the unit to dry naturally.
- Please do NOT use thinners, benzine or alcohol.



COATED FABRIC ON THE BACK CUSHION

- 1 Wipe the seat fabric with a cloth that has been soaked in a mild detergent solution and then thoroughly wrung out.
 - 2 Use a brush to apply a mild detergent to areas where the coated fabric has become particularly soiled. Be careful not to brush the fabric too much as this may damage it.
 - 3 Next wipe the fabric with a cloth that has been moistened with just water and then thoroughly wrung out.
 - 4 Allow the fabric to dry naturally.
- Please do NOT use thinners, benzine or alcohol.

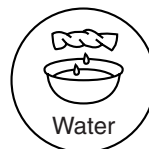

CAUTION

- **Always unplug the unit before cleaning it. Never touch a power plug with wet hands.**
Failure to follow these instructions may lead to electrocution or burns.

TROUBLESHOOTING

PROBLEM	
Problem	Cause and Remedy
<p>Motor Noises</p> <ul style="list-style-type: none"> • It sounds and feels like the massage heads are straining to get over wrinkles in the cloth. • The motor groans when it comes under load. • There is excessive noise during Tapping. (The noise is greater at the top of the massage lounger.) • There is a creaking noise when the massage heads are in operation. • There is a rattling sound when the massage heads move up or down. • The belt can be heard rotating. • There is a rubbing sound produced by the massage heads rubbing on the seat fabric. • There is a noise when the backrest cushion moves over the armrest when the seat is reclining. • There is a noise when I sit down. • There is a strange sound when the massage heads move in and out. • When the power switch is turned on there is a humming sound. • Air massage-related sounds. There is a hissing sound of air escaping. There is a humming sound from the pump. • The legrest rattles. • There is an unstable sound when air escapes during the leg stretch. 	<p>▶ These sounds are perfectly normal and will not have any effect on the operation of the unit.</p>
<p>The massage heads stop during operation.</p>	<p>▶ <u>When excessive force is applied to the massage heads during operation, in the interests of safety the massage heads may stop moving.</u> If all markings and buttons on the controller start to flash, which is extremely unusual, turn off the power switch, wait for approximately 10 seconds and then turn the power switch on again. If the massage heads stop again, position yourself so that your back is not completely in contact with the backrest.</p>
<p>The massage heads do not come up to the shoulder or neck.</p>	<p>▶ The position of the massage heads is incorrect. (See Page 12)</p>
<p>The height of the left and right massage heads is different.</p>	<p>▶ An alternating tapping method is employed, which means that this phenomenon will naturally occur. There is nothing wrong with the unit.</p>
<p>It is not possible to recline the unit. The legrest cannot be raised or lowered.</p>	<p>▶ <u>If the unit encounters an obstacle or if excessive force is exerted on it during operation, in the interests of safety the unit will come to a stop.</u> If all markings and buttons on the controller start to flash, which is extremely unusual, turn off the power switch, wait for approximately 10 seconds and then turn the power switch on again.</p>

Problem	Cause and Remedy
Reclining does not take place even though a massage is started in pre-programs. (The seat does not automatically recline.)	▶ In some cases the seat may not automatically recline depending on the position (angle) of the backrest or the legrest. (See Page 11)
The backrest does not return to the upright position.	▶ The backrest will not return to the upright position if the timer is activated or the ⏻ button is pressed. (Pressing ⏻ twice will return the backrest to its original position.) (See Page 19)
It is not possible to switch from Swedish and Knead to Hawaiian and Compression.	▶ Switching can be hindered when the user's body weight is not resting on the massage heads. Shift your weight so that your body is contact with the massage heads.
The legrest will not return to its original position.	▶ If the length of the legrest has been extended, the legrest will strike the floor, preventing from returning to its original position. Try again after retracting it to its original length.
The unit will not operate at all.	▶ <ul style="list-style-type: none"> • The power cord has been disconnected. (See Page 8) • The power switch on the unit has not been turned on. (See Page 8) • A Pre-Program button or Manual Operation button hasn't been pressed after pressing ⏻. (See Pages 11, 14)
The unit has been damaged.	▶ Stop using the unit immediately.
The power cord or power plug is abnormally hot.	▶ Stop using the unit immediately.

SPECIFICATIONS

Power Supply:	AC120V 60 Hz
Power Consumption:	220 W
Upper Body Massage	
Massage Area (Up-Down):	Approx. 27 in. (67.5 cm)
Massage Area (Left-Right):	Distance between Massage Heads during Operation Approx. 2 – 7 in. (6.0 – 18.0 cm)
Up-Down Movement Speed:	Approx. 20 – 35 sec. return.
Massage Speed:	Knead: Approx. 20 – 30 cycles/min. Swedish: Approx. 30 – 50 cycles/min. Compression: Approx. 20 – 30 cycles/min. Hawaiian: Approx. 30 – 50 cycles/min. Soft Shiatsu: Approx. 120 – 200 cycles/min. Tap: Approx. 300 – 700 cycles/min. Full Roll: Approx. 20 – 35 sec./cycle (Movement range: Approx. 21.1 in. (53.5 cm)) Regional Roll: Approx. 7 – 9 sec./cycle (Movement range: Approx. 4.7 in. (12 cm))
Lower Body Massage	
Air Pressure	Strong: Approx. 24.0 kPa Medium: Approx. 14.5 kPa Weak: Approx. 8.0 kPa
Reclining Angle:	Backrest: Approx. 120° – 170° Legrest: Approx. 0° – 85°
Automatic Shut-Off:	Approx. 15 min. for both upper and lower body
Dimensions:	
When not reclined. (H × W × D)	42.9 × 26.8 × 47.2 in. (109 × 68 × 120 cm)
When reclined. (H × W × D)	24.0 × 26.8 × 66.1 in. (61 × 68 × 168 cm)
Weight of Unit:	Approx. 133 lbs (60 kg)
Dimensions of Box (H × W × D):	30.7 × 30.3 × 47.6 in. (78 × 77 × 121 cm)
Weight in Box:	Approx. 161 lbs (73 kg)
Maximum User Weight:	Approx. 264 lbs (120 kg)
Minimum Distance from Wall:	15.7 in. (40 cm)

**Panasonic Consumer
Electronics Company**

One Panasonic Way 4A-3
Secaucus, New Jersey 07094
1-800-338-0552 for questions and comments.
www.panasonic.com/massage

Panasonic Canada Inc.

5770 Ambler Drive
Mississauga, ON L4W 2T3
905-624-5010
www.panasonic.ca